

150 % RUPTURE BASIN

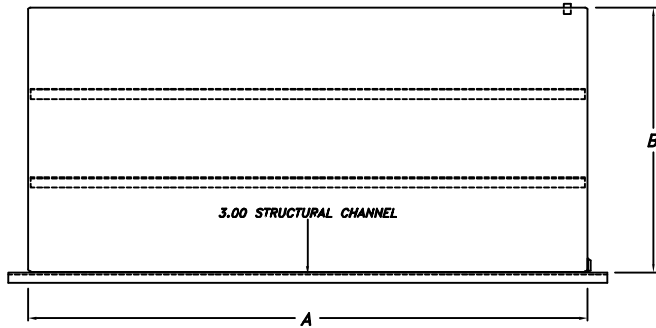

RIGHT SIDE VIEW

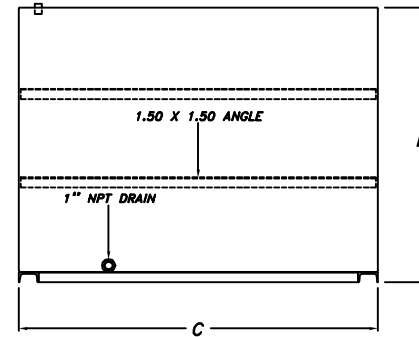

FRONT VIEW

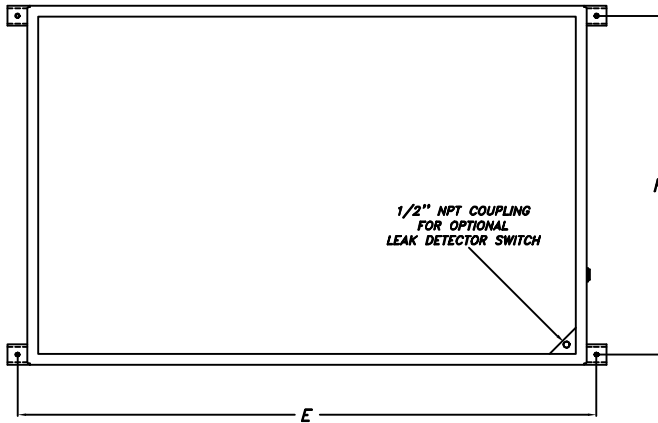

TOP VIEW

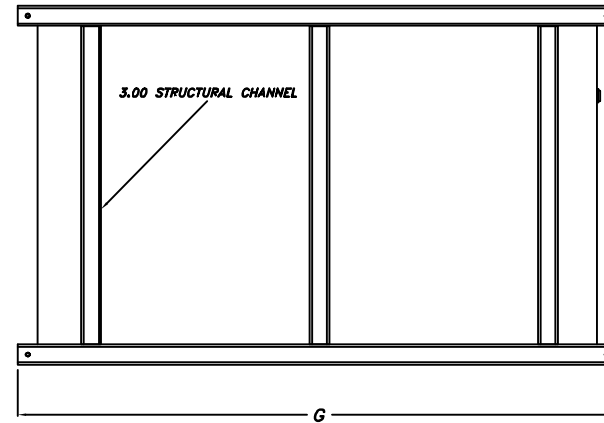

BOTTOM VIEW

DIM.	200 GAL.	275 GAL.	300 GAL.	400 GAL.	500 GAL.	600 GAL.	700 GAL.	800 GAL.	900 GAL.	1000 GAL.
A	60.00	72.00	72.00	78.00	84.00	94.00	104.00	108.00	112.00	126.00
B	40.00	40.00	40.00	40.00	40.00	40.00	40.00	40.00	40.00	40.00
C	32.00	35.00	38.00	42.00	54.00	58.00	60.00	67.00	72.00	72.00
D	41.50	41.50	41.50	41.50	41.50	41.50	41.50	41.50	41.50	41.50
E	63.00	75.00	75.00	81.00	87.00	97.00	107.00	111.00	115.00	129.00
F	29.00	32.00	35.00	39.00	51.00	55.00	57.00	64.00	69.00	69.00
G	66.00	78.00	78.00	84.00	90.00	100.00	110.00	114.00	118.00	132.00

1.50 X 1.50 ANGLE IS USED WHEN TANK HEIGHT(B) IS 30" OR OVER

RUPTURE BASIN ENDS,BOTTOM & SHELL - 12 GAUGE	
DIMENSION SUBJECT TO CHANGE WITHOUT NOTICE	
150% RUPTURE BASIN FOR PY200 - PY1000 SINGLE WALL	
 PRYCO, INC. MECHANICSBURG, IL	
DIMENSIONS IN INCHES	DRAWN BY: RES
	CHECKED BY: R.J.W.
	DATE: 07-20-2000
	SHEET NO: 1 OF 1
	SCALE: 1 = 25
	DWG NUMBER: RB150-C SW